

# Industrial Ethernet Switch - FL SWITCH 3005T



2891032

<https://www.phoenixcontact.com/us/products/2891032>

Please be informed that the data shown in this PDF document is generated from our Online Catalog. Please find the complete data in the user documentation. Our General Terms of Use for Downloads are valid.



Managed Ethernet switch with five RJ45 ports at 10/100 Mbps and operating temperature of -40°C ... +75°C

## Product Description

FL SWITCH 3000 managed industrial Ethernet switches combine extensive network performance and security features with complete IEEE redundancy (STP/RSTP/MST) and 15 ms recovery time extended ring redundancy. Unique web customization provides a simplified user interface for today's applications and scalable functionality for future needs. A comprehensive mix of fiber optic and copper port connections meets a wide range of applications.

## Your advantages

- RJ45 ports support a transmission speed of 10/100 Mbps
- Fiber-optic ports support 100 Mbps
- -40 to 75°C and -10 to 60°C ambient temperature versions
- Extensive web diagnostics with configurable LED and remote alarm contacts
- Security options with cable locking
- Secure web-based and SNMP-based management
- Unique cleanup function hides unused configuration pages, reducing complexity, maintenance and startup times
- Auto negotiation and autocrossing detection simplifies installation and setup

## Commercial Data

Item number	2891032
Packing unit	1 pc
Minimum order quantity	1 pc
Sales Key	C23
Product Key	DNN125
Catalog Page	Page 314 (C-6-2019)
GTIN	4046356659130
Weight per Piece (including packing)	1,223 g
Weight per Piece (excluding packing)	1,200 g
Customs tariff number	85176200
Country of origin	TW

## Technical Data

### Dimensions

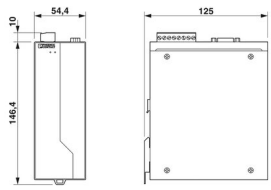
Dimensional drawing		
Width		54.4 mm
Height		146.4 mm
Depth		125 mm

### Notes

#### Utilization restriction

EMC note	EMC: class A product, see manufacturer's declaration in the download area
----------	---

### Material specifications

Housing material	Aluminum
------------------	----------

### Mounting

Mounting type	DIN rail mounting
---------------	-------------------

### Interfaces

#### Ethernet (RJ45)

Connection method	RJ45
Note on the connection method	Auto negotiation and autocrossing
Transmission speed	10/100 Mbps
Transmission physics	Ethernet in RJ45 twisted pair
Transmission length	100 m
No. of channels	5 (RJ45 ports)

### Product properties

Type	Block design
Product type	Switch
MTTF	45.1 Years (MIL-HDBK-217F standard, temperature 25°C, operating cycle 100%)

#### Insulation characteristics

Protection class	III (VDE 0106, IEC 60536)
------------------	---------------------------

#### Switch functions

Basic functions	Store and forward switch, Extended Ring and IEEE redundancy,
-----------------	--

# Industrial Ethernet Switch - FL SWITCH 3005T



2891032

<https://www.phoenixcontact.com/us/products/2891032>

	Multicast control, IGMP snooping, trunking, Port and Tagging VLANs, Port and IEEE 802.1x security, SNMP V3 and Https security, SNTP, web customization, user accounts
Signal contact control voltage	24 V DC
Signal contact control current	100 mA
Redundancy	ERR (Extended ring redundancy)
Status and diagnostic indicators	LEDs: U <sub>S1</sub> , U <sub>S2</sub> (redundant voltage supply), link and activity per port

## Security functions

Basic functions	Store and forward switch, Extended Ring and IEEE redundancy, Multicast control, IGMP snooping, trunking, Port and Tagging VLANs, Port and IEEE 802.1x security, SNMP V3 and Https security, SNTP, web customization, user accounts
-----------------	--

## Electrical properties

Local diagnostics	US1, US2 Supply voltage Green LED
	LNK/ACT Link status/data transmission Green LED
	100 Data transmission speed Red LED
Maximum power dissipation for nominal condition	4.8 W
Test section	Supply voltage/functional ground 500 V 1 min.
Transmission medium	Copper

## Supply

Supply voltage (DC)	24 V DC (redundant)
Supply voltage range	12 V DC ... 48 V DC
Inrush current	5.04 A (3.1 ms)
Residual ripple	3.6 V <sub>PP</sub> (within the permitted voltage range)
Typical current consumption	185 mA (at U <sub>S</sub> = 24 V DC)

## Function

Signal contact control voltage	24 V DC
Signal contact control current	100 mA

## Connection data

### Connection technology

Connection name	Power supply
-----------------	--------------

### Power supply

Connection method	Pluggable COMBICON screw connections
Conductor cross section, rigid	0.2 mm <sup>2</sup> ... 2.5 mm <sup>2</sup>
Conductor cross section, flexible	0.2 mm <sup>2</sup> ... 2.5 mm <sup>2</sup>
Conductor cross section AWG	24 ... 12
Stripping length	7 mm

## Ambient conditions

Degree of protection	IP20
----------------------	------

Ambient temperature (operation)	-40 °C ... 75 °C
Ambient temperature (storage/transport)	-40 °C ... 85 °C
Permissible humidity (operation)	5 % ... 95 % (non-condensing)
Permissible humidity (storage/transport)	5 % ... 95 % (non-condensing)
Air pressure (operation)	57 kPa ... 108 kPa (up to 4850 m above mean sea level)
Air pressure (storage/transport)	57 kPa ... 108 kPa (up to 4850 m above mean sea level)

## Approval data

### Conformity/Approvals

Conformance	CE-compliant
ATEX	□ II 3 G Ex nA nC IIC T4 Gc
EU-type examination certificate	DEMKO 16 ATEX 1616X
IECEX	Ex nA nC IIC T4 Gc
IECEX certificate	IECEX UL 16.0094X
UL, USA / Canada	Class I, Div. 2, Groups A, B, C, D

## EMC data

Conformance with EMC directives	IEC 61000-6-2 IEC 61000-4-2 (ESD) Criterion B
	IEC 61000-4-3 (immunity to radiated interference) Criterion A
	IEC 61000-4-4 (burst) Criterion A
	IEC 61000-4-5 (surge) Criterion B
	IEC 61000-4-6 (immunity to conducted interference) Criterion A
	IEC 61000-4-8 (immunity to magnetic fields) Criterion A
	EN 55022 (emitted interference) Class A
	NEMA TS-2
Noise emission	EN 61000-6-4
Noise immunity	EN 61000-6-2:2005

## LED signaling

Status display	LEDs: U <sub>S1</sub> , U <sub>S2</sub> (redundant voltage supply), link and activity per port
----------------	--

# Industrial Ethernet Switch - FL SWITCH 3005T



2891032

<https://www.phoenixcontact.com/us/products/2891032>

## Drawings

Dimensional drawing

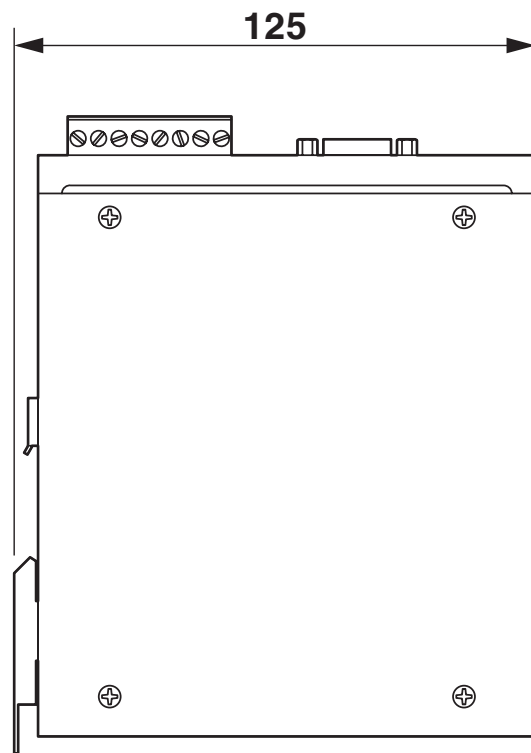
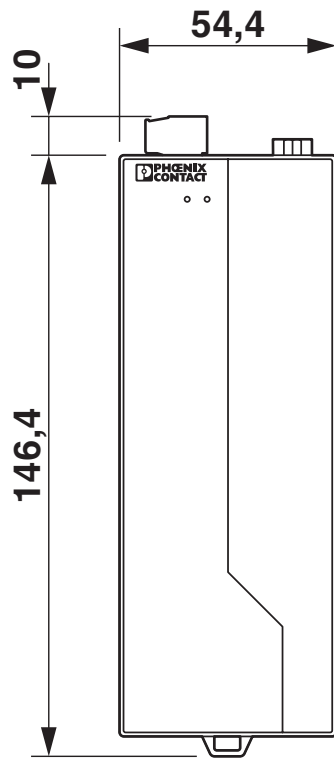

# Industrial Ethernet Switch - FL SWITCH 3005T



2891032

<https://www.phoenixcontact.com/us/products/2891032>

## Approvals



**EAC**

Approval ID: RU \*-DE.A\*08.B.00739



**UL Listed**

Approval ID: FILE E 140324



**cUL Listed**

Approval ID: FILE E 140324



**cUL Listed**

Approval ID: FILE E 238705



**UL Listed**

Approval ID: FILE E 238705



**IECEX**

Approval ID: IECEX UL 16.0094X



**cUL Listed**

Approval ID: File E 360692



**UL Listed**

Approval ID: File E 360692



**UL Listed**

Approval ID: FILE E 196811



**cUL Listed**

Approval ID: FILE E 196811



**ATEX**

Approval ID: DEMKO 16 ATEX 1616X

# Industrial Ethernet Switch - FL SWITCH 3005T



2891032

<https://www.phoenixcontact.com/us/products/2891032>

## Classifications

### ECLASS

ECLASS-9.0	19170106
ECLASS-10.0.1	19170401
ECLASS-11.0	19170401

### ETIM

ETIM 8.0	EC000734
----------	----------

### UNSPSC

UNSPSC 21.0	43222600
-------------	----------

# Industrial Ethernet Switch - FL SWITCH 3005T



2891032

<https://www.phoenixcontact.com/us/products/2891032>

## Environmental Product Compliance

REACH SVHC	Lead 7439-92-1
China RoHS	Environmentally Friendly Use Period = 10; For information on hazardous substances, refer to the manufacturer's declaration available under "Downloads"

2891032

<https://www.phoenixcontact.com/us/products/2891032>

## Accessories

### PCB connector

PCB connector - MSTB 2,5/ 8-ST - 1754562

<https://www.phoenixcontact.com/us/products/1754562>



PCB connector, nominal cross section: 2.5 mm<sup>2</sup>, color: green, nominal current: 12 A, rated voltage (III/2): 320 V, contact surface: Tin, type of contact: Female connector, number of potentials: 8, number of rows: 1, number of positions: 8, number of connections: 8, product range: MSTB 2,5/...-ST, pitch: 5 mm, connection method: Screw connection with tension sleeve, screw head form: L Slotted, conductor/PCB connection direction: 0 °, locking clip: - Locking clip, plug-in system: COMBICON MSTB 2,5, locking: without, mounting: without, type of packaging: packed in cardboard

---

### Surge protection device

Surge protection device - DT-LAN-CAT.6+ - 2881007

<https://www.phoenixcontact.com/us/products/2881007>



Surge protection in accordance with Class E<sub>A</sub> (CAT6<sub>A</sub>), for Gigabit Ethernet (up to 10 Gbps), token ring, FDDI/CDDI, ISDN, and DS1. Suitable for Power over Ethernet (PoE++ / 4PPoE) "Mode A" and "Mode B". RJ45 attachment plug with separate grounding cable and ground connection snap-on foot for NS 35 DIN rails.

# Industrial Ethernet Switch - FL SWITCH 3005T

2891032

<https://www.phoenixcontact.com/us/products/2891032>

## Patch cable

Patch cable - FL CAT5 PATCH 0,5 - 2832263

<https://www.phoenixcontact.com/us/products/2832263>

Patch cable, CAT5, assembled, 0.5 m



---

## Patch cable

Patch cable - FL CAT5 PATCH 1,0 - 2832276

<https://www.phoenixcontact.com/us/products/2832276>

Patch cable, CAT5, assembled, 1 m



# Industrial Ethernet Switch - FL SWITCH 3005T



2891032

<https://www.phoenixcontact.com/us/products/2891032>

## Patch cable

Patch cable - FL CAT5 PATCH 2,0 - 2832289

<https://www.phoenixcontact.com/us/products/2832289>

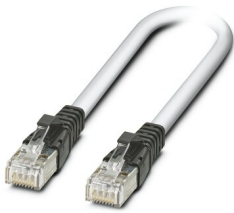

Patch cable, CAT5, assembled, 2 m

---

## Patch cable

Patch cable - NBC-R4AC-R4AC-IE8A/.../... - 1411854

<https://www.phoenixcontact.com/us/products/1411854>

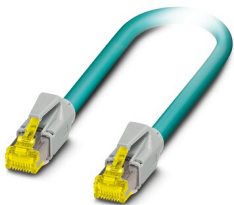

Patch cable, degree of protection: IP20, number of positions: 8, 10 Gbps, CAT6<sub>A</sub>, cable outlet: straight, Ethernet

# Industrial Ethernet Switch - FL SWITCH 3005T



2891032

<https://www.phoenixcontact.com/us/products/2891032>

## Patch cable

Patch cable - NBC-R4AC/10G-R4AC/10G-94F/2,0 - 1408360

<https://www.phoenixcontact.com/us/products/1408360>

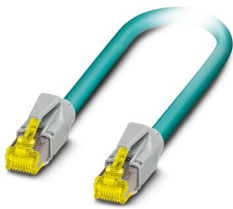

Patch cable, CAT6<sub>A</sub>, 4-pair, shielded, connection not crossed (line), assembled at both ends with RJ45/IP20 connectors, outer sheath material: PUR, length: 2.0 m

---

## Patch cable

Patch cable - NBC-R4AC/10G-R4AC/10G-94F/3,0 - 1408365

<https://www.phoenixcontact.com/us/products/1408365>

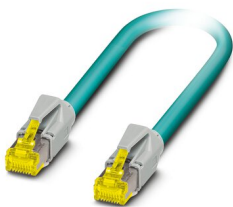

Patch cable, CAT6<sub>A</sub>, 4-pair, shielded, connection not crossed (line), assembled at both ends with RJ45/IP20 connectors, outer sheath material: PUR, length: 3.0 m

# Industrial Ethernet Switch - FL SWITCH 3005T



2891032

<https://www.phoenixcontact.com/us/products/2891032>

## Port Guard Security Element

Port Guard Security Element - FL SEC PAC 4TX - 2832865

<https://www.phoenixcontact.com/us/products/2832865>

Layer1 security elements for four RJ45 network connections for use with patch boxes and panels



---

## DIN rail adapter

DIN rail adapter - FL DIN RA - 2891053

<https://www.phoenixcontact.com/us/products/2891053>

The FL DIN RA is installed in a standard, 19-inch rack (EIA-310-D, IEC 60297-3-100) to allow DIN rail mounted equipment to be rack mounted.



# Industrial Ethernet Switch - FL SWITCH 3005T



2891032

<https://www.phoenixcontact.com/us/products/2891032>

## Dust protection

Dust protection - FL RJ45 PROTECT CAP - 2832991

<https://www.phoenixcontact.com/us/products/2832991>

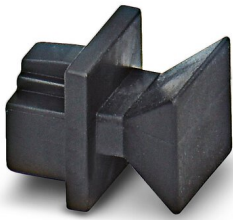

Dust protection caps for RJ45 socket

---

## End clamp

End clamp - E/NS 35 N - 0800886

<https://www.phoenixcontact.com/us/products/0800886>

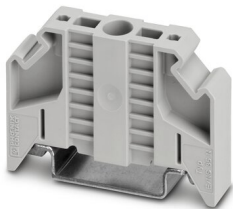

End clamp, width: 9.5 mm, color: gray

---

Phoenix Contact 2022 © - all rights reserved  
<https://www.phoenixcontact.com>

Phoenix Contact USA  
586 Fulling Mill Road  
Middletown, PA 17057, United States  
(+717) 944-1300  
[info@phoenixcon.com](mailto:info@phoenixcon.com)